

INSTALLATION INSTRUCTIONS FOR LED EXIT SIGN

Model No.:ESA11

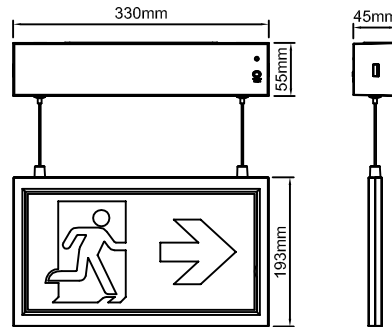

Product Feature

Power Supply	: 220-240VAC, 50/60 Hz	Emergency Duration	: 1 Hour / 3 Hours
Power Consumption	: Max. 3.5W	Protection Class	: II
Ambient Operating Temp	: -5°C...+45°C	IP Rating	: IP20
Charge Time	: 24 Hours	Function	: AUTO test and Manual test
Operation	: Maintained and Non maintained	Installation	: Wall mount or Ceiling mount
		Viewing distance	: 30m

Precautions

This product should be installed by a registered electrician in accordance with local standards and electrical regulations. Take care to ensure the mains supply is isolated before installation.

Service & Operation

Normal Operation: The green indicator light on the front of the unit stays on. The indicator will go out if the mains supply fails, the internal charger malfunctions, or the unit in test mode.

Battery: Sealed Ni-Cad or Ni-Mh rechargeable battery pack. Battery should be replaced when the required duration is no longer achieved. To avoid any damage to the fixture and ensure its performance, the battery should be replaced with same brand and type.

Test Switch: Press the test switch button, LED indicator will go out and the sign will be illuminate from its battery pack.

Mounting Instructions

① Dispart mounting plate

② Wall mounting or Ceiling mounting

① Insert flat screwdriver into slot on side of unit, pry off and remove the mounting plate from unit.
② Disconnect AC connector from PCBA.

③ Knock out appropriate center cable entry hole and mounting screw hole on the mounting plate.
④ Route AC supply wire through center hole of mounting plate.
⑤ Fix mounting plate on the mount surface with screws and anchor nuts.

3 Wiring connection

Suitable cable 0.75-2.5mm²

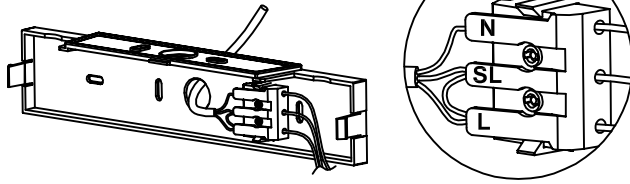

Connect the AC supply wire to terminal block. Refer to wiring instruction showed below.

4 Connect battery

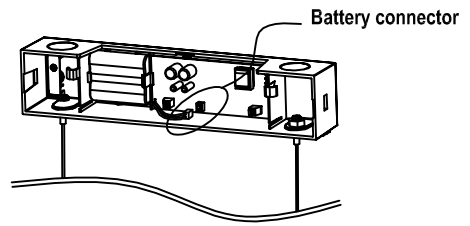

Connect battery male and female connector inside of mounting bracket.

5 Change pictogram when necessary

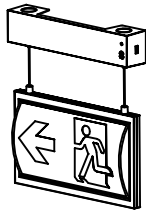

Remove the pictogram on the unit, select other pictogram you need then insert into slot of panel.

6 Finish installation

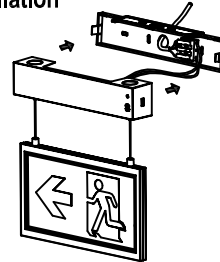

Snap AC supply on PCBA and then snap fixture to mounting plate.

Wiring Instructions

Maintained Wiring

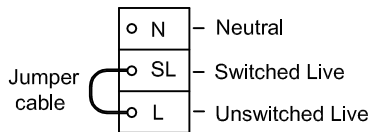

Maintained (default operation):
Connect L,N and leave jumper cable connected.

Non-Maintained Wiring

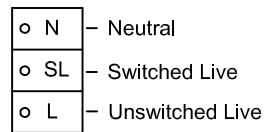

Non-maintained:
Connect L,N and remove jumper cable.

Pictogram Styles

LUPG31



LUPG32



LUPG33



Mounting Options

Wall mounting

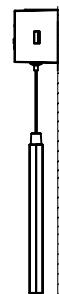

Ceiling mounting

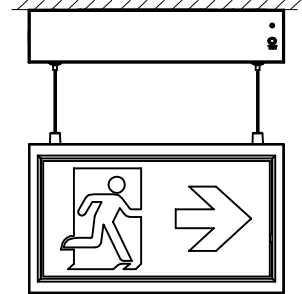

Technical Information

Model Number	Input Voltage	Charge Duration	Discharge Duration	Battery	Power Consumption	LED
ESA11/1H/MT(AT)	220-240V~ 50/60Hz	24h	1 h	Ni-cad or Ni-Mh 3.6V 0.6Ah	3.5W Max.	SMD 2835 14 pcs
ESA11/3H/MT(AT)	220-240V~ 50/60Hz	24h	3 h	Ni-cad or Ni-Mh 3.6V 0.9Ah	3.5W Max.	SMD 2835 14 pcs
ESA11/3H/DA	220-240V~ 50/60Hz	24h	3 h	Ni-Mh 3.6V 2.0Ah	3.5W Max.	SMD 2835 14 pcs